

Technický popis $V = 7500l$

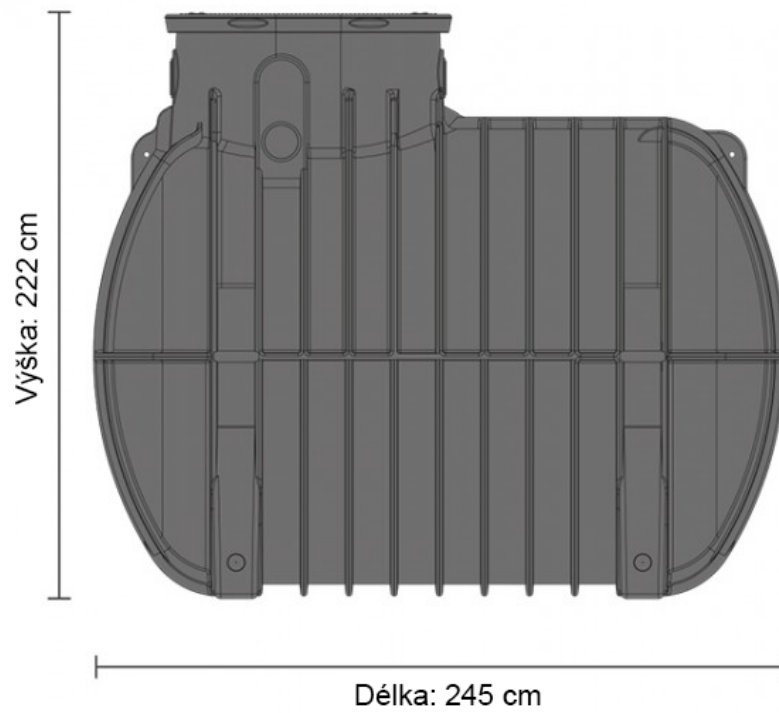

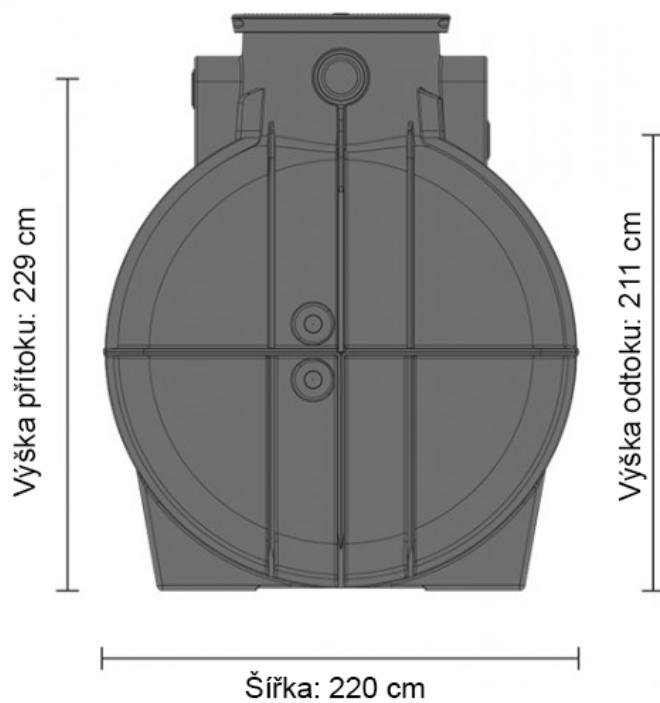

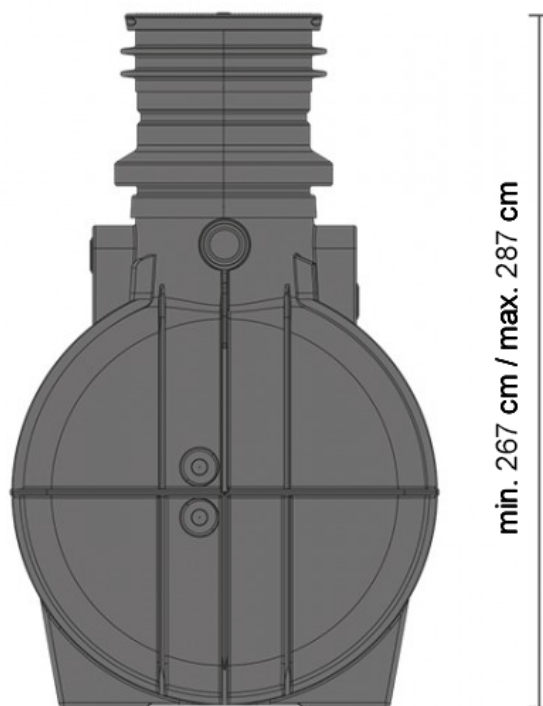

Nádrž s komínem