

Technický popis $V = 3000l$

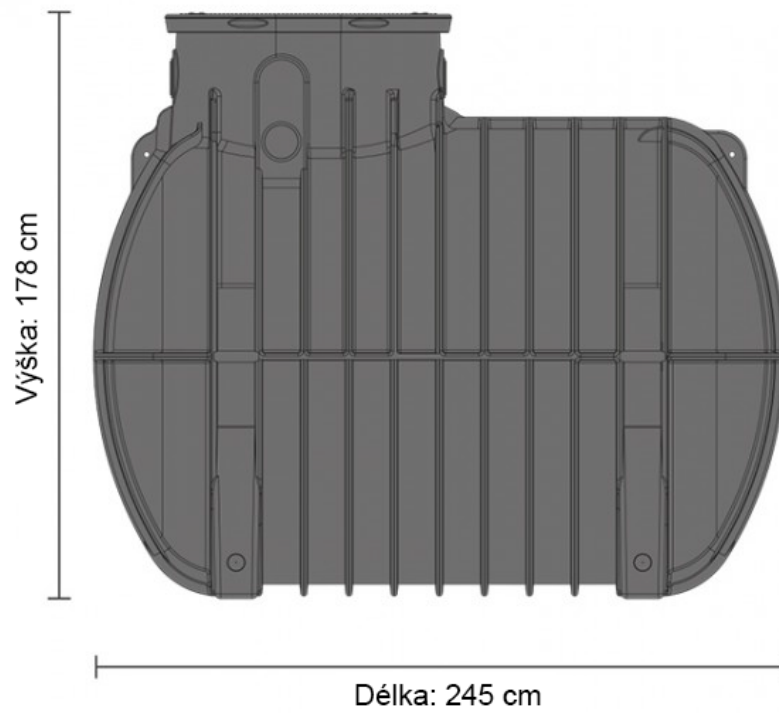

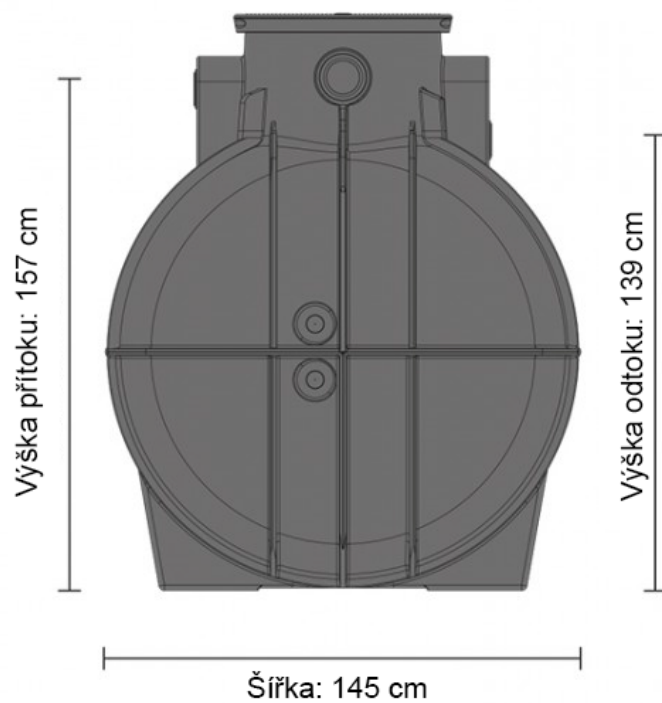

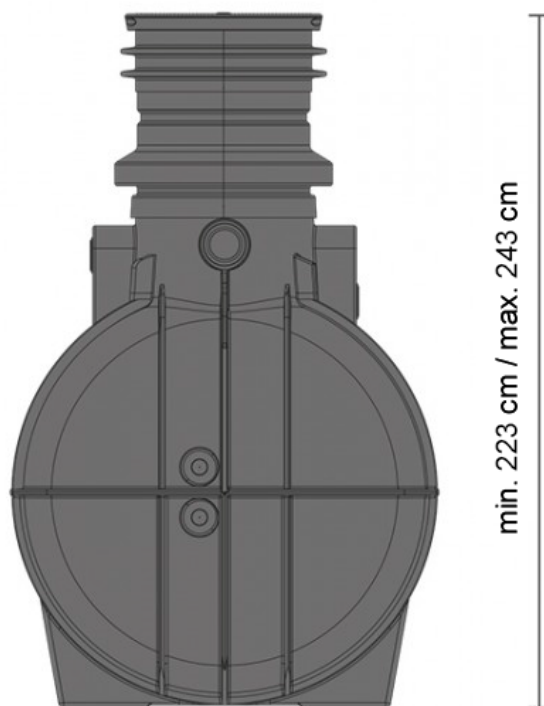

Nádrž s komínem